

VRF INDOOR UNITS



TRUST AIR CONDITIONING EQUIPMENT CO.
Prepared By: Engineering & R & D Department.

Indoor units troubleshooting

1 PCB description	2
2 Display description	6
3 Error definition and display content table	11
4 Troubleshooting	14

توجه:

شرکت تراست حق تغییر مشخصات دستگاه ها را در جهت بهبود و ارتقای کیفیت برای خود محفوظ می دارد.

2013-07

1 PCB description

There are two shapes of PCB that is used for all types of indoor unit.

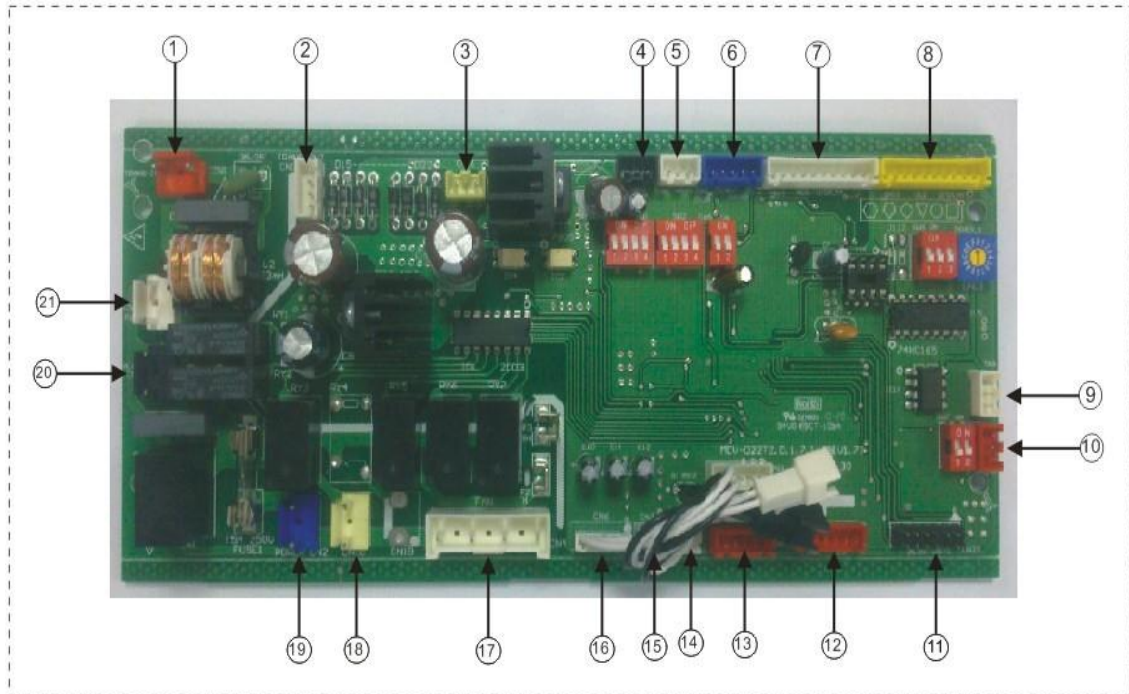

Shape A

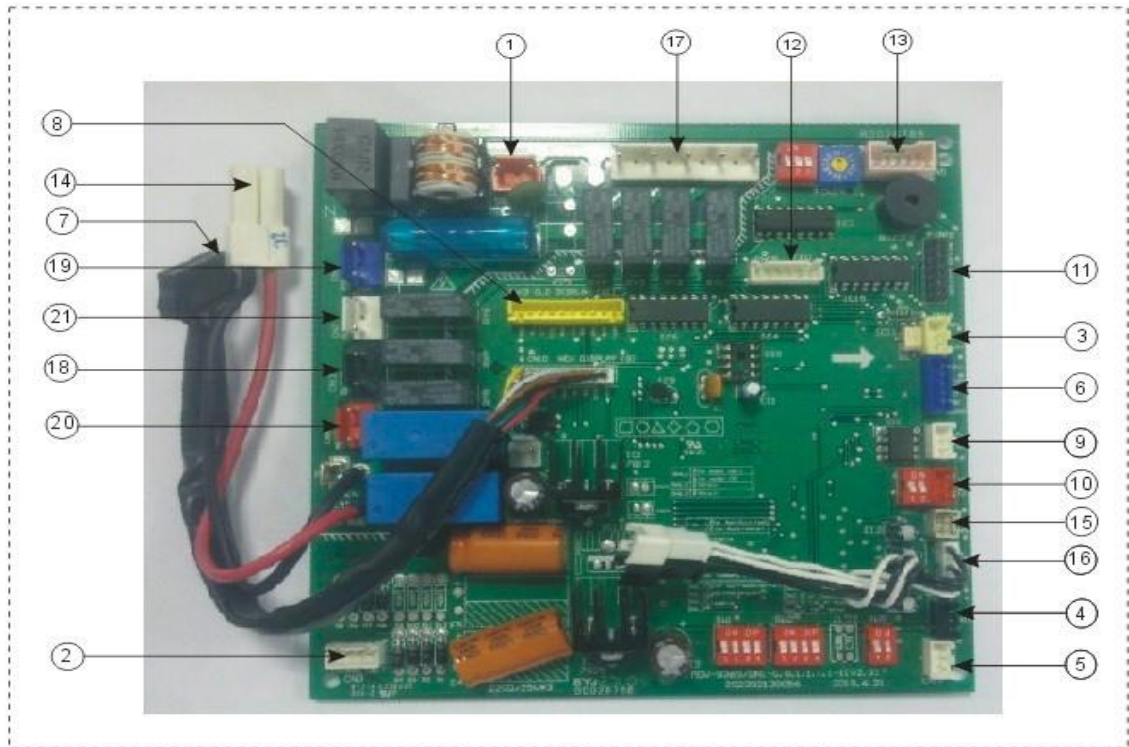



Shape B

Explanation of PCB





No.	Content	Note
1	Power input of transformer	220V AC
2	Power output of transformer	Yellow-Yellow: AC9V Brown-Brown: AC13.5V
3	Port for remote ON/OFF switch	5V DC
4	Port for infrared sensor	5V DC
5	Water level switch	5V DC
6	Port for network module	5V DC
7	Port for new display board	5V DC
8	Port for old display board	5V DC
9	Communication port of X Y E	2.5~2.7V DC
10	Communication port of P Q E	2.5~2.7V DC
11	Port for on-line writing program	5V DC
12	Electric expansion valve drive port	12V DC
13	Swing motor drive port	12V DC
14	Port for electric auxiliary heater	12V DC
15	The evaporator outlet temperature detect port	5V DC
16	Indoor ambient and middle evaporator temperature detect port	5V DC
17	Port for indoor fan motor	220V AC
18	Reserved	220V AC
19	Power input port	220V AC
20	Port for alarm	220V AC
21	Port for water pump	220V AC

Dial codes definition



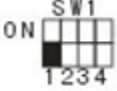
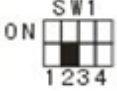

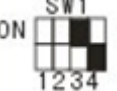
0/1 definition

	Means 0
	Means 1

SW1 definition

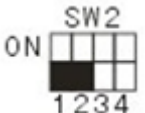
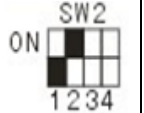
	1 means factory test mode 0 means default auto addressing mode		1 means DC fan is chosen 0 means AC fan is chosen
	Reserved		Reserved
	Reserved		Reserved

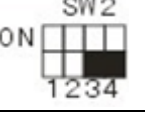
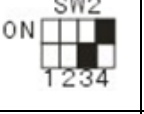
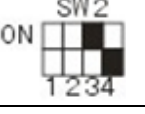

SW2 definition

	00 means shutting down the unit to stop cold air at 15°C		01 means shutting down the unit to stop cold air at 20°C
	10 means shutting down the unit to stop cold air at 24°C		11 means shutting down the unit to stop cold air at 26°C
	00 means the time of stopping fan (when no capacity need) is 4 minutes		01 means the time of stopping fan (when no capacity need) is 8 minutes
	10 means the time of stopping fan (when no capacity need) is 12 minutes		11 means the time of stopping fan (when no capacity need) is 16 minutes

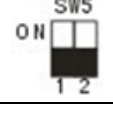
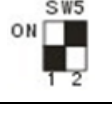
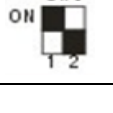
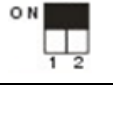

SW5 definition

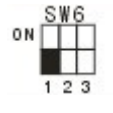
	00 means temperature compensation value is 6°C under heating mode		01 means temperature compensation value is 2°C under heating mode
	10 means temperature compensation value is 4°C under heating mode		11 means temperature compensation value is 8°C under heating mode

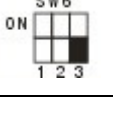
SW6 definition

	1 means old display panel 0 means new display panel		1 means auto air blow under auto mode 0 means auto air blow under non-auto mode
	Reserved		

J1 J2 definition

	Without jumper J1 for auto restart function		With jumper J1 for non-auto restart function
	Reserved		

PCB classification

Applicable models	Diagram
DH(7.1~16kW), DF(12.5~28kW), DM,C4(7.1~14kW), FS(exposed)	
DH(20/25/28/40/45/56kW)	
Below 11.2kW FC (include 11.2kW)	
14kW FC	
C2	
W1	
CO	
P4(2.2~4.5kW),T3	

Note:

- DH High static pressure duct
- DF High static pressure fresh air processing unit
- DM Middle static pressure duct
- DL Low static pressure duct
- C1 One-way cassette
- C2 Two-way cassette
- C4 (P4) Four-way cassette (Include compact)
- W1 Wall mounted

2 Display description

2.1 Mode display

Two types of display: digital tube display and four LED display

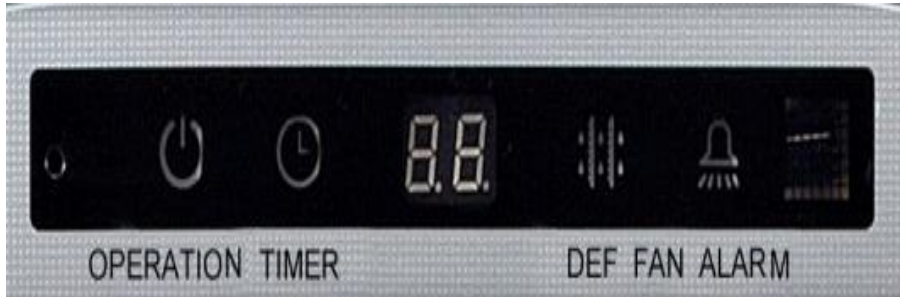



Digital tube display



Four LED display

2.2 Status display

Status	Digital tube display	Four LED display
Standby	Two digital tube display "--"	Operation light flash slow
Shutdown	Two digital tube display "--"	Operation light off 
Starting	Digital tube displays setting temperature in cooling and heating mode	Operation light on 
	Digital tube displays the indoor temperature in air supply mode	
Timing	Turn on "Timer" light	Turn on timer light 

2.3 Digital tube display

2.3.1 Query instructions

No.	Content	Note
0	Normal display	
1	Communication address of IDU	0~63
2	Dial code of IDU capacity	
3	Network address of IDU	0~63
4	The actual setting temperature	
5	The actual indoor temperature T1	Minimum value -9℃
6	The actual indoor temperature T1	Minimum value -9℃
7	The middle evaporator temperature T2	Minimum value -9℃
8	The evaporator outlet temperature T2B	Minimum value -9℃
9	Error code	
10	--	

2.3.2 Error code

Display content	Definition
FE	IDU don't have address when the first time power on
H0	M-home mismatch error
E0	Mode conflict error
E1	Communication error between IDU and ODU
E2	Indoor ambient temperature sensor (T1) error
E3	Middle evaporator temperature sensor (T2) error
E4	The evaporator outlet temperature sensor (T2B) error
E7	EEPROM error
Ed	Outdoor units error
EE	Water level alarm error
H1	Outdoor temp. sensor error (for fresh air processing unit)
H2	Outdoor low temp. error (for fresh air processing unit)
H3	Outdoor high temp. error (for fresh air processing unit)

2.4 Four LED display

2.4.1 Error code

Display content	Definition
Operation and timer lights flash	IDU don't have address when the first time power on
All LED lights flash	M-home mismatch error
Timer light flash	Communication error between IDU and ODU
Operation light flash	Indoor ambient temperature sensor (T1) error
Alarm light flash	Water level alarm error
Defrost light flash	Mode conflict error
Alarm light flash slow	Outdoor units error
Defrost light flash slow	EEPROM error

Note:

Power-on reset: the operation light flash slow;

Standby: all the LED lights off; 

Starting: the operation light on; 

Anti-cold or preheat defrosting: defrost light on; 

Timing: timer light on. 

Flash fast for twice per second, flash slow for once per second.

2.4.2 Communication address and capacity of IDU display method:

1. Pressing the manual button continued for 5 seconds, it will display the indoor units communication address.

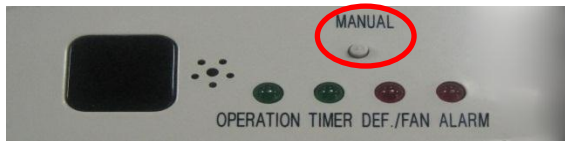

LED light	Operation	Timer	DEF./FAN	Alarm
Code	8	4	2	1

	Communication address	Four LED display
Buzzer not warning	00---15	Normally on
Buzzer not warning	16---31	Flash
Buzzer warning	32---47	Normally on
Buzzer warning	48---63	Flash

For example:

Pressing the manual button continued for 5 seconds:

- If the “Operation”, “Timer” and “DEF./FAN” lights are normally on and the buzzer isn’t warning, that means the address code is $14=(8+4+2)$
- If the four LED lights are flash and the buzzer isn’t warning, the address code should plus 16, that means the address code is $31=16+(8+4+2+1)$
- If the “Operation”, “Timer” and “DEF./FAN” lights are normally on and the buzzer is warning, that means the address code is $46=32+(8+4+2)$
- If the four LED lights are flash and the buzzer is warning, that means the address code is $63=48+(8+4+2+1)$

2. Pressing the manual button continued for 10 seconds, it will display the capacity of indoor units.

Dial code	Capacity (x100W)	HP
0	22	0.8
1	28	1.0
2	36	1.2
3	45	1.6
4	56	2.0
5	71	2.5
6	80	3.0
7	90	3.2
8	112	4.0
9	140	5.0
A	160	6.0
B	160	6.0
C	160	6.0
D	160	6.0
E	160	6.0
F	160	6.0

For example

Pressing the manual button continued for 10 seconds:

- If all the LED lights turn off, that means the capacity code is 0 and the capacity of indoor units is $22 \times 100\text{W}$ (0.8HP);
- If the “Timer” and “Alarm” lights are normally on, that means the capacity code is $5 = (4 + 1)$ and the capacity of indoor unit is $71 \times 100\text{W}$ (2.5HP);
- If the “Operation” and “Alarm” lights are normally on, that means the capacity code is $9 = (8 + 1)$ and the capacity of indoor unit is $140 \times 100\text{W}$ (5.0HP);
- If all the LED lights turn on, that means the capacity code is $F = (8 + 4 + 2 + 1)$ and the capacity of indoor unit is $160 \times 100\text{W}$ (6.0HP).

The above basic principle just applies to single PCB, if the indoor unit has more than one PCB, or one PCB can achieve a virtual multi blocks function, you must use the basic principle to calculate the achievable capacity of single PCB at first, then add all the value as the capacity of the indoor unit .

For example

The high static pressure duct has capacity of 20kW, 25kW, 28kW and larger capacity of 40kW, 45kW, 56kW.

- The “Operation” light is normally on, that means the capacity code is 8 and the achievable capacity of single PCB is $112 \times 100\text{W}$ (4.0HP), then add the value of two PCB, so the capacity of indoor unit is $200 \times 100\text{W}$ (8.0HP);
- The “Operation” and “Alarm” lights are normally on, that means the capacity code is $9 = (8 + 1)$ and the achievable capacity of single PCB is $140 \times 100\text{W}$ (5.0HP), then add the value of two PCB, so the capacity of indoor unit is $280 \times 100\text{W}$ (10HP);
- The “Operation” light is normally on, that means the capacity code is 8 and the achievable capacity of single PCB is $112 \times 100\text{W}$ (4.0HP), then add the value of four PCB, so the capacity of indoor unit is $450 \times 100\text{W}$ (16HP);
- The “Operation” and “Alarm” lights are normally on, that means the capacity code is $9 = (8 + 1)$ and the achievable capacity of single PCB is $140 \times 100\text{W}$ (5.0HP), then add the value of four PCB, so the capacity of indoor unit is $560 \times 100\text{W}$ (20HP).

3 Error definition and display content table

3.1 Table 1

Error		Display content	
No.	Error definition	Q4,G unit	
		Four LED display	Digital tube display
1	Communication error between IDU and ODU	LED2 flash fast	E1
2	Indoor ambient temperature sensor (T1) error	LED1 flash fast	E2
3	Middle evaporator temperature sensor (T2) error	LED1 flash fast	E3
4	The evaporator outlet temperature sensor (T2B) error	LED1 flash fast	E4
5	Water level alarm error	LED4 flash fast	EE
6	EEPROM error	LED1 flash fast	E7
7	Mode conflict error	LED3 flash fast	E0
8	Outdoor units error	LED4 flash slow	Ed
9	IDU don't have address when the first time power on	LED1,LED2 flash slow	FE

3.2 Table 2

Error		Display content	
No.	Error definition	T1,T1-FA,T2,T2-C,T3,Q1,DL unit	
		Four LED display	Digital tube display
1	Communication error between IDU and ODU	LED2 flash fast	/
2	Indoor ambient temperature sensor (T1) error	LED1 flash fast	/
3	Middle evaporator temperature sensor (T2) error	LED1 flash fast	/
4	The evaporator outlet temperature sensor (T2B) error	LED1 flash fast	/
5	Water level alarm error	LED4 flash fast	/
6	EEPROM error	LED1 flash fast	/
7	Mode conflict error	LED3 flash fast	/
8	Outdoor units error	LED4 flash slow	/
9	IDU don't have address when the first time power on	LED1,LED2 flash slow	/
10	Outdoor temperature sensor error(only for T1-FA)		H1
11	Outdoor low temperature error(only for T1-FA)		H2
12	Outdoor high temperature error(only for T1-FA)		H3

3.4 Table 3

Error		Display content	
No.	Error definition	C2 unit	
		Four LED display	Digital tube display
1	Communication error between IDU and ODU	LED2 flash fast	E1
2	Indoor ambient temperature sensor (T1) error	LED1 flash fast	E2
3	Middle evaporator temperature sensor (T2) error	LED1 flash fast	E3
4	The evaporator outlet temperature sensor (T2B) error	LED1 flash fast	E4
5	Water level alarm error	LED4 flash fast	EE
6	EEPROM error	LED1 flash fast	E7
7	Mode conflict error	LED3 flash fast	E0
8	Outdoor units error	LED4 flash slow	Ed
9	IDU don't have address when the first time power on	LED1,LED2 flash slow	FE
10	Swing motor don't have feedback signal in the early of power on	/	E8

Note:

- C4 unit (P4)** Four- way cassette (Include compact)
- W1 unit Wall-mounted
- DH unit High static pressure duct
- DM unit Middle static pressure duct
- DL unit Low static pressure duct
- C1 unit One-way cassette
- FC unit Floor and ceiling
- C2 unit Two-way cassette
- LED1 Operation light
- LED2 Timer light
- LED3 DEF./FAN light
- LED4 Alarm light

Flash fast for twice per second, flash slow for once per second.

4 Troubleshooting

4.1 E1: Communication error between IDU and ODU

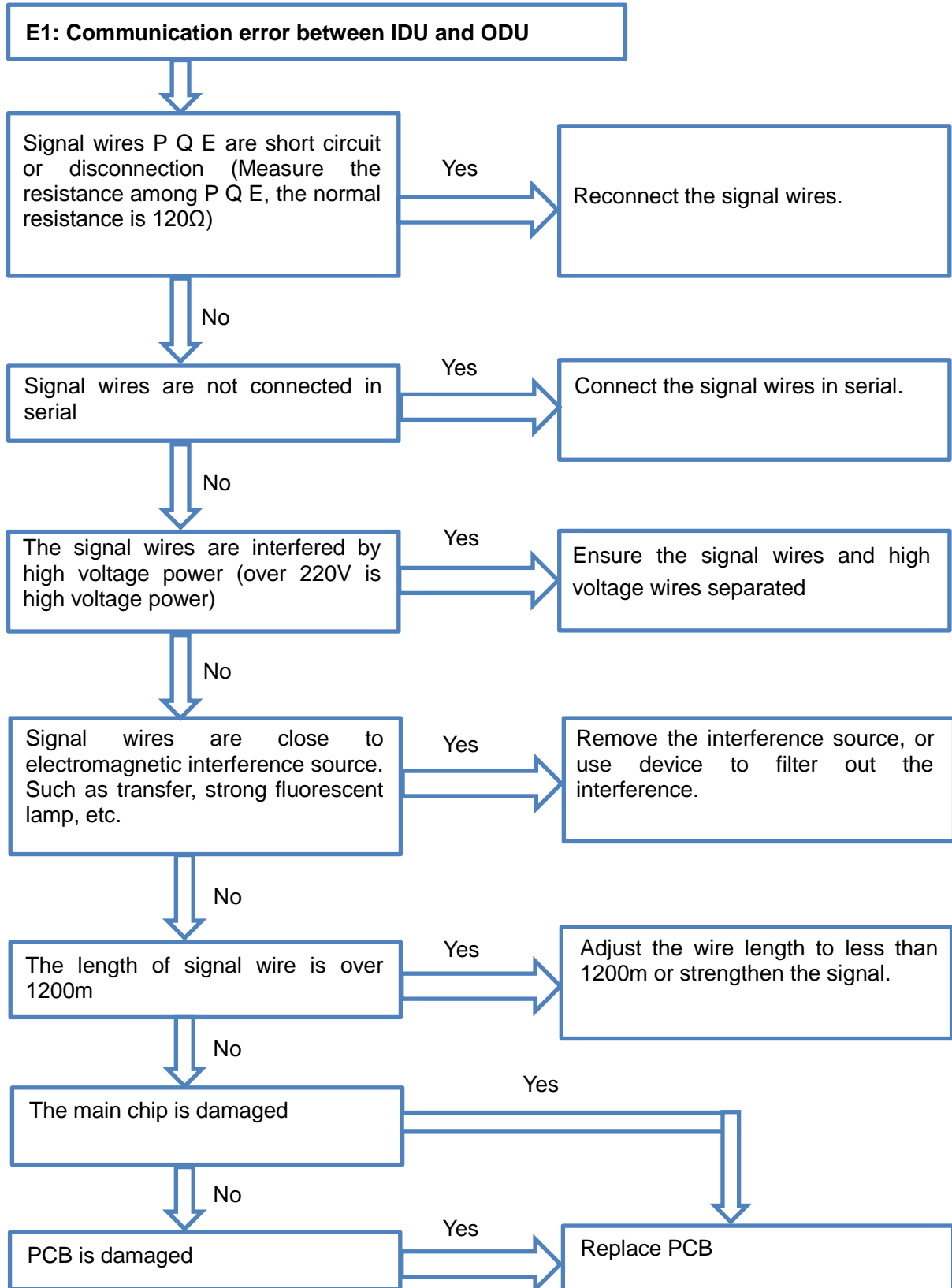

4.2 E2: Indoor ambient temperature sensor (T1) error

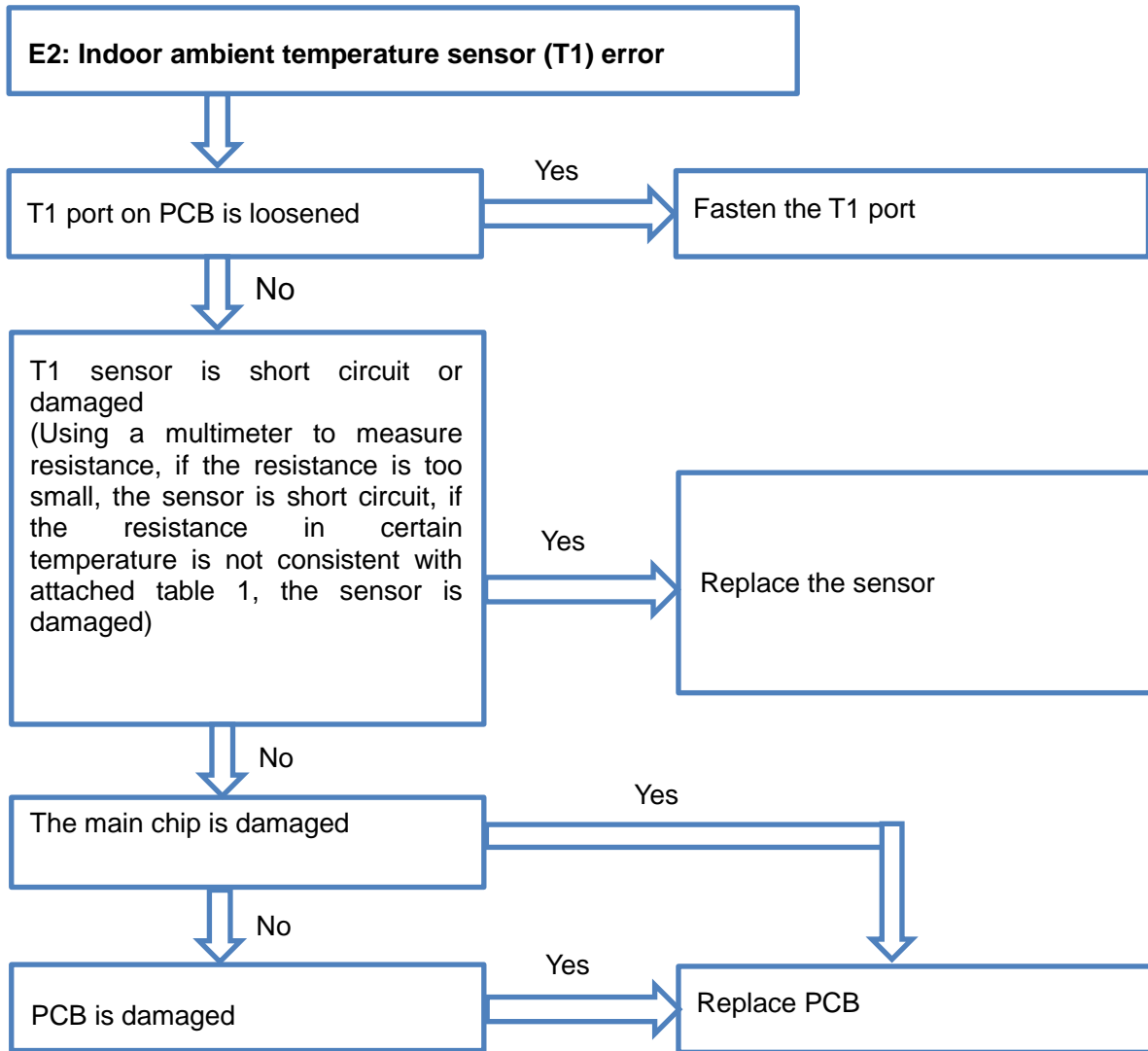

4.3 E3: Middle evaporator temperature sensor (T2) error

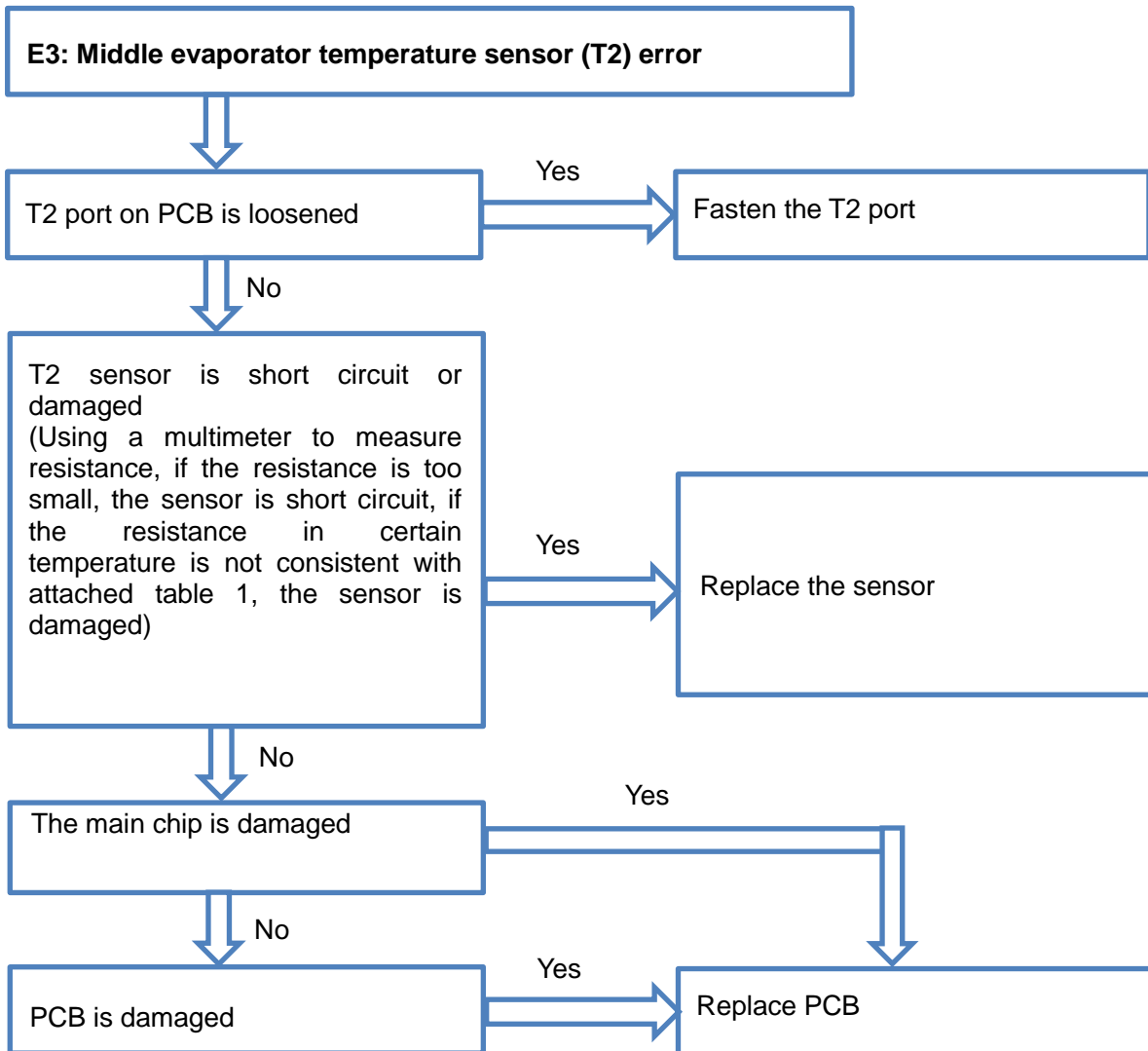

4.4 E4: The evaporator outlet temperature sensor (T2B) error

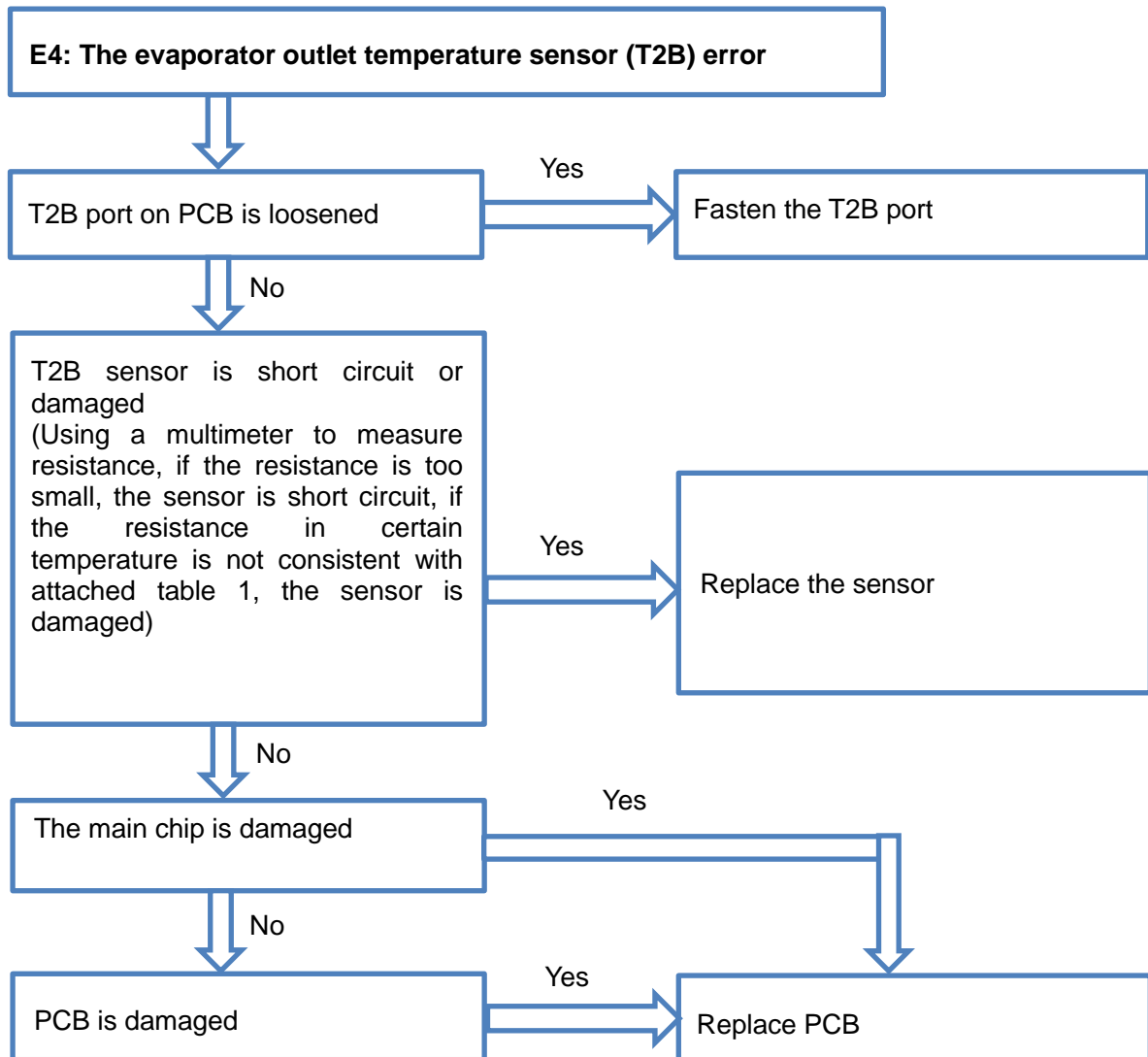

4.5 EE: Water level alarm error

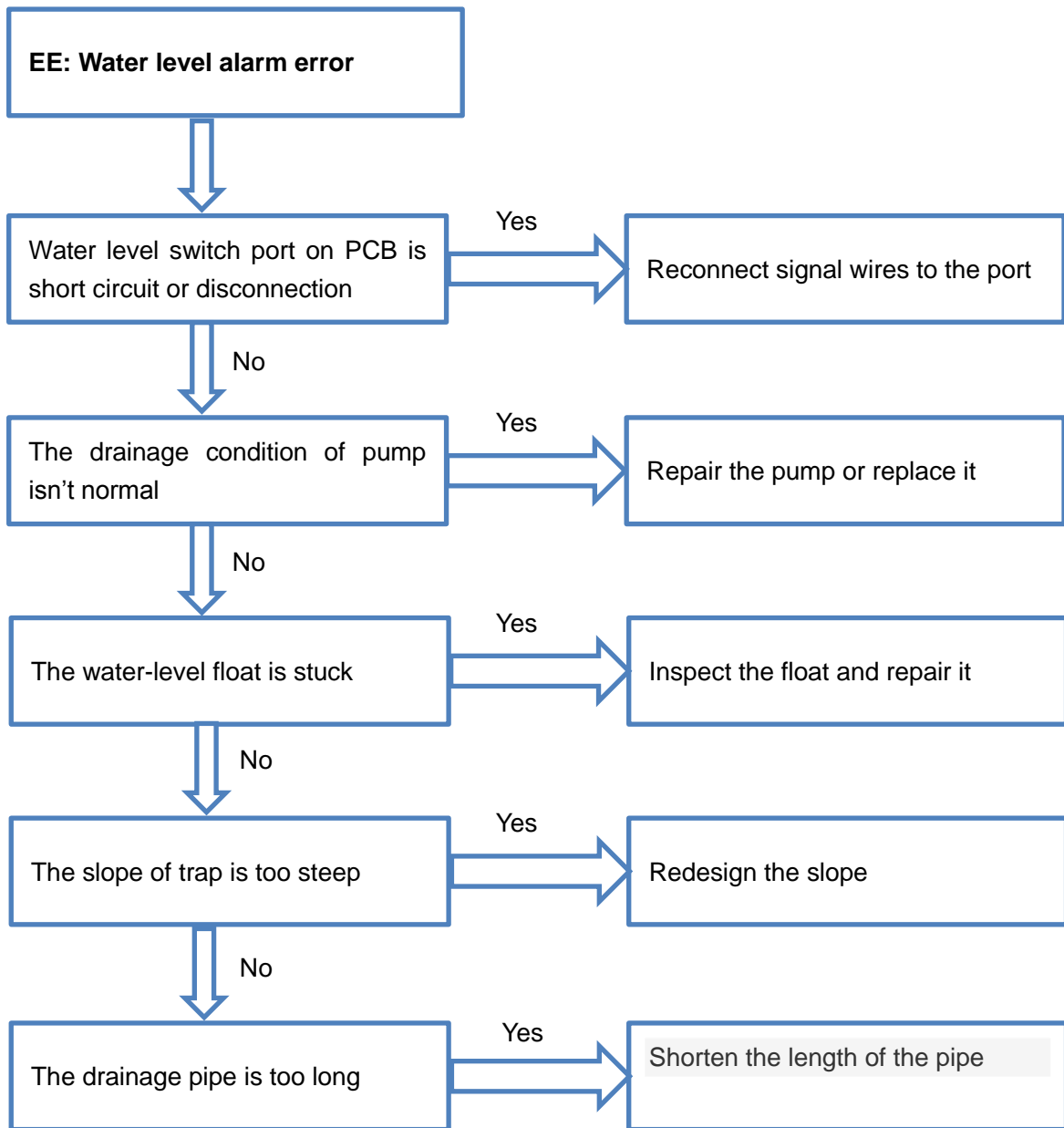

4.6 E7: EEPROM error

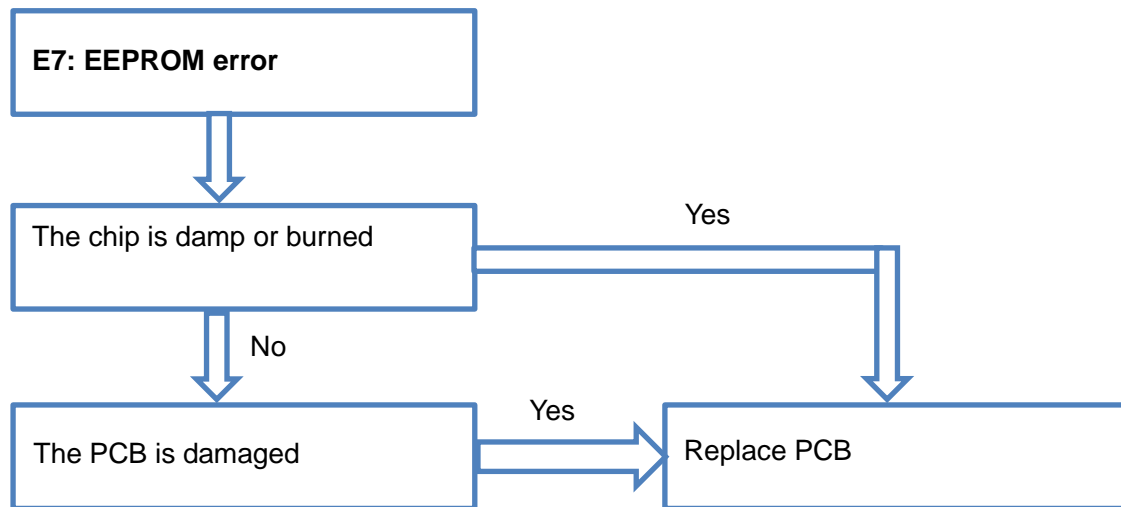

4.7 E0: Mode conflict error

The heating mode has the priority in default.

In cooling or fan only mode.

- If the system receives heating signal when it's in cooling mode or fan only mode, the outdoor unit will stop to heat after 3 minutes. The indoor unit which was in cooling or fan only mode will display corresponding error code or the DEF./FAN light of the indoor unit will flash fast.

In heating mode.

- If the system receives cooling or fan only signal when the system is in heating mode, the system will ignore the order and these units will display mode conflict error or the DEF./FAN light of the indoor unit will flash fast.

4.8 Ed: Outdoor units error

It should base on outdoor units troubleshooting and solution to solve the error.

4.9 FE: IDU don't have address when the first time power on

ODU dial code of automatic addressing

- It makes sure that the IDU address is different .

Remote controller and wired remote control set address

- It makes sure that the IDU address is different.

New added function—auto addressing

- 1) New automatic addressing is just a newly designed indoor-address distributed method which will automatically do by outdoor unit, without manual addressing. When the unit is under testing, as the outdoor and indoor units are powered on simultaneously, the outdoor unit will automatically distribute different address to every indoor unit in less than 10 minutes.
- 2) With regarding to the customer's desire of some kind fixed address or regular addresses for all indoor units, it can be achieved by wireless remote controller.

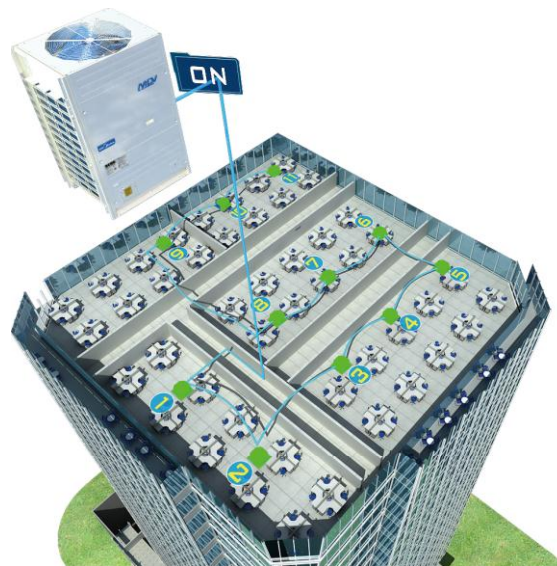

4.10 E8: Swing motor don't have feedback signal in the early of power on

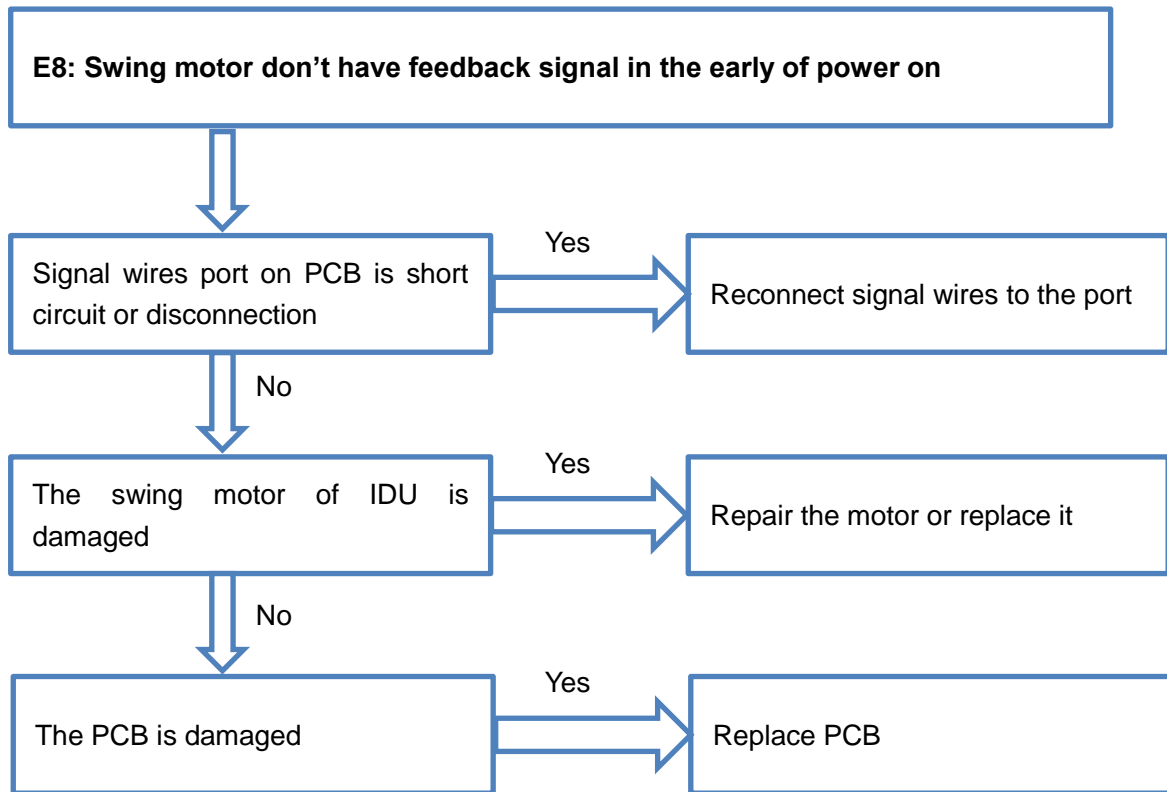

4.11 H0: M-home mismatch error

VRF ODU match the Mini VRF IDU

- 1. It must make sure that IDU and ODU are the same type;
- 2. If it displays this error, it should take the same type units to replace the IDU or ODU.

Mini VRF ODU match the VRF IDU

- 1. It must make sure that IDU and ODU are the same type;
- 2. If it displays this error, it should take the same type units to replace the IDU or ODU.

4.12 H1: Outdoor temperature sensor error (for fresh air processing unit)

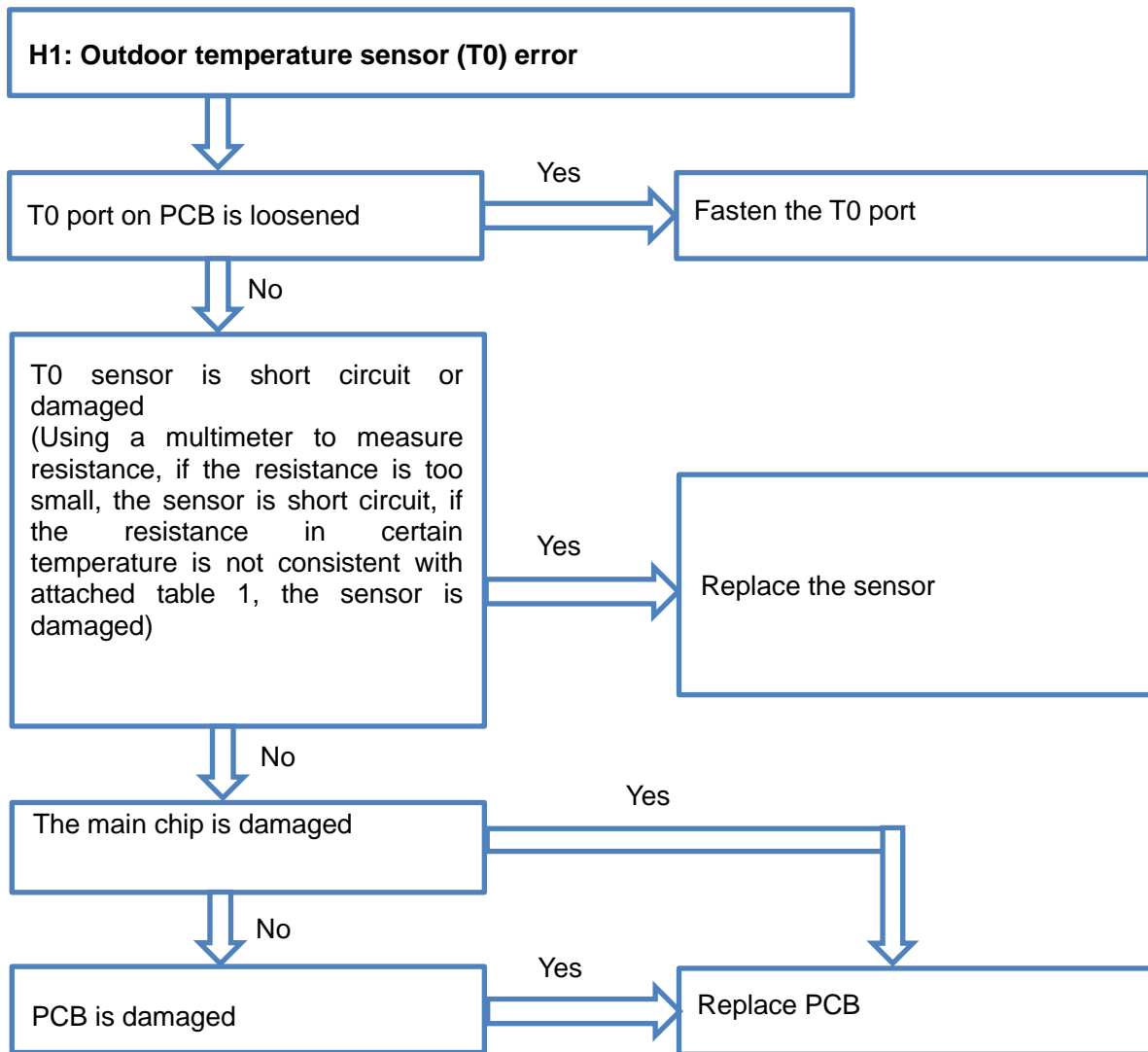

4.13 H2: Outdoor low temperature error (for fresh air processing unit)

In heating mode, when $T_0 < -5^{\circ}\text{C}$ for 5 minutes, capacity requirement is 0, EXV will close and then open to 96P, indoor fan closed. It displays "H2" error. When $T_0 \geq -3^{\circ}\text{C}$, it will recover.

4.14 H3: Outdoor high temperature error (for fresh air processing unit)

In cooling mode, when $T_0 > 43^{\circ}\text{C}$ for 5 minutes, capacity requirement is 0, EXV will close(-40P), indoor fan closed. It displays "H3" error. When $T_0 \leq 41^{\circ}\text{C}$, it will recover.

Attached table 1:

Resistance value of ambient temperature sensor and pipe temperature sensor

Temperature (°C)	Resistance value (kΩ)	Temperature (°C)	Resistance value (kΩ)	Temperature (°C)	Resistance value (kΩ)	Temperature (°C)	Resistance value (kΩ)
-20	115.266	20	12.6431	60	2.35774	100	0.62973
-19	108.146	21	12.0561	61	2.27249	101	0.61148
-18	101.517	22	11.5	62	2.19073	102	0.59386
-17	96.3423	23	10.9731	63	2.11241	103	0.57683
-16	89.5865	24	10.4736	64	2.03732	104	0.56038
-15	84.219	25	10	65	1.96532	105	0.54448
-14	79.311	26	9.55074	66	1.89627	106	0.52912
-13	74.536	27	9.12445	67	1.83003	107	0.51426
-12	70.1698	28	8.71983	68	1.76647	108	0.49989
-11	66.0898	29	8.33566	69	1.70547	109	0.486
-10	62.2756	30	7.97078	70	1.64691	110	0.47256
-9	58.7079	31	7.62411	71	1.59068	111	0.45957
-8	56.3694	32	7.29464	72	1.53668	112	0.44699
-7	52.2438	33	6.98142	73	1.48481	113	0.43482
-6	49.3161	34	6.68355	74	1.43498	114	0.42304
-5	46.5725	35	6.40021	75	1.38703	115	0.41164
-4	44	36	6.13059	76	1.34105	116	0.4006
-3	41.5878	37	5.87359	77	1.29078	117	0.38991
-2	39.8239	38	5.62961	78	1.25423	118	0.37956
-1	37.1988	39	5.39689	79	1.2133	119	0.36954
0	35.2024	40	5.17519	80	1.17393	120	0.35982
1	33.3269	41	4.96392	81	1.13604	121	0.35042
2	31.5635	42	4.76253	82	1.09958	122	0.3413
3	29.9058	43	4.5705	83	1.06448	123	0.33246
4	28.3459	44	4.38736	84	1.03069	124	0.3239
5	26.8778	45	4.21263	85	0.99815	125	0.31559
6	25.4954	46	4.04589	86	0.96681	126	0.30754
7	24.1932	47	3.88673	87	0.93662	127	0.29974
8	22.5662	48	3.73476	88	0.90753	128	0.29216
9	21.8094	49	3.58962	89	0.8795	129	0.28482
10	20.7184	50	3.45097	90	0.85248	130	0.2777
11	19.6891	51	3.31847	91	0.82643	131	0.27078
12	18.7177	52	3.19183	92	0.80132	132	0.26408
13	17.8005	53	3.07075	93	0.77709	133	0.25757
14	16.9341	54	2.95896	94	0.75373	134	0.25125
15	16.1156	55	2.84421	95	0.73119	135	0.24512
16	15.3418	56	2.73823	96	0.70944	136	0.23916
17	14.6181	57	2.63682	97	0.68844	137	0.23338
18	13.918	58	2.53973	98	0.66818	138	0.22776
19	13.2631	59	2.44677	99	0.64862	139	0.22231



Air Conditioning Systems

Cooling & Heating

TRUST AIR-CONDITIONING EQUIPMENT CO.

Shiraz office: 8 th floor, Alvand Bldg., Dostan St.,
Moaliabad Ave., SHIRAZ, IRAN., Post code: 71877-14446

Tel.: +98-71-36341070

Fax.: +98-71-36341094

Tehran office: No. 19- koohe nour St.- Motahhari St.-

TEHRAN, IRAN., Post code: 15876-73111

Tel.: +98-21-89389

Fax.: +98-21-88541903

Ahwaz office: No. 309- Kaveh St.- AHWAZ, IRAN., Post code: 61939-47911

Tel.: +98-61-32230647-8 E-mail: info@trustacs.com

Fax.: +98-61-32230647 Web site: <http://www.trustacs.com>

برند برتر در اولین جشنواره بین المللی
برترین نام و نشان های تجاری ایران

